

Article number: 60415236028

Description: Timing Belt Pulley 36 AT5 28/2

Measures

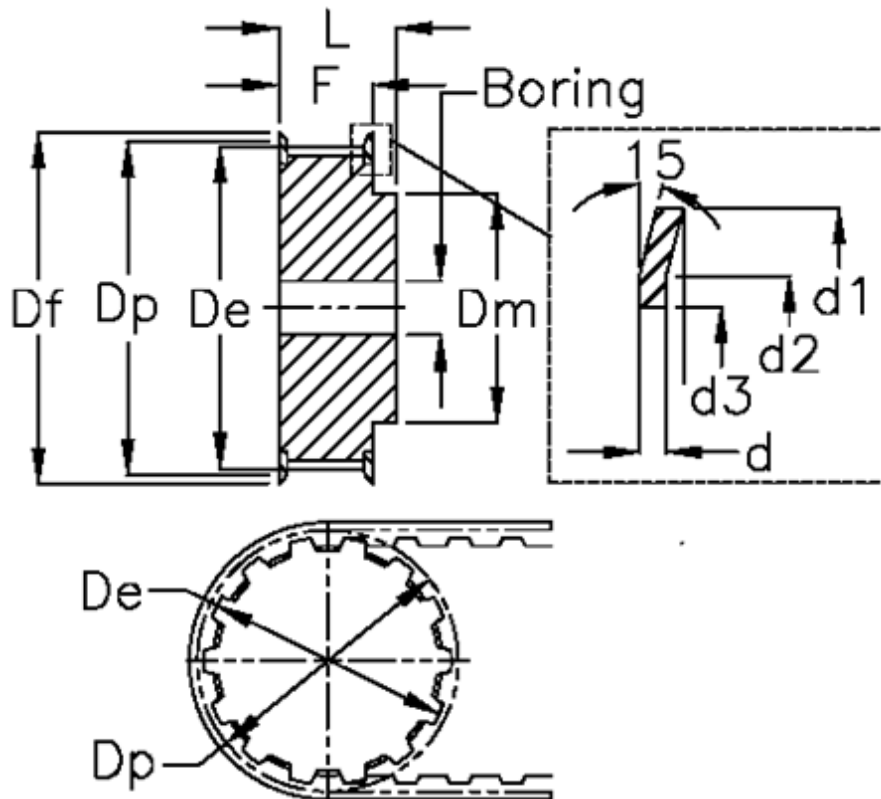

Belt width = - 25 mm	Dp	= 44.6
d = 1	F	= 30
d1 = 48	Flange type	= F18
d2 = 43.5	L	= 36
d3 = 37	Pre-drilled	= 8
De = 43.35	Tooth number	= 28
Df = 48	Type	= AT5
Dm = 32	Weight	= 0.135